

4" SUBMERSIBLE PUMPS

C A T A L O G U E



50Hz 4" SUBMERSIBLE PUMPS
4" DALGIÇ POMPA

 **vansan**
WATER TECHNOLOGIES



Genel Özellikler

General Features

- Maksimum kapasite 24 m³/saat
Capacity up to 24 m³/h
- Maksimum motor gücü 7.5 Kw
Rated motor power output up to 7.5 Kw
- Maksimum su sıcaklığı 35°C
Maximum water temperature 35 °C
- Maksimum pompa çapı 98 mm (Kablo koruması dahil)
Maximum overall pump diameter 98 mm (Including cable guard)
- Kabul edilebilir maksimum kum miktarı 50g / m³
Maximum permissible quantity of suspended sand of 50g/m³
- Çıkış Bağlantısı > 1¼", 1½", 2"
Discharge Connection > 1¼", 1½", 2"



4" DALGIÇ POMPALAR **50Hz**
4" SUBMERSIBLE PUMPS





4" Dalgıç Pompa Yedek Parçaları / 4" Submersible Pump Spare Parts

Ürün Kodu Sistemi

Product Code System

VSP SN 4 001 / 19

Kademe sayısı / Number of stages

Nominal debi / Nominal capacity (m³/h)

Anma çapı / Nominal diameter (40: 4 inch)

Çark malzemesi / Impeller material (N: noryl)

Difüzör malzemesi / Diffuser material (S: stainless steel)

Pompa tipi / Pump type (VSP: Vansan submersible pump)

No	Parça Adı / Part Name	Malzeme / Material
1	Çıkış Haznesi / Discharge Head	Paslanmaz Döküm (AISI 304) / Casted Stainless Steel (AISI 304)
2	Klepe Diski / Valve Disc	Paslanmaz Çelik (AISI 304) / Stainless Steel (AISI 304)
3	Klepe Oturma Çemberi / Valve Seat Retainer	Paslanmaz Çelik (AISI 304) / Stainless Steel (AISI 304)
4	Klepe Oturma Diski / Valve Seat	Paslanmaz Çelik (AISI 304) / Stainless Steel (AISI 304)
5	Çıkış Haznesi Segmanı / Valve Locking Ring	Paslanmaz Çelik (AISI 304) / Stainless Steel (AISI 304)
6	Ara Parça Çemberi / Adapter Ring	Noril / Noryl
7	Ara Parça Burcu / Bushing	Noril / Noryl
8	Ara Parça Yatağı / Bearing Spacer	Poliüretan / Polyurethane
9	Ara Parça / Valve Housing	Noril / Noryl
10	Difüzör / Diffuser	PC, %20 Cam Elyaf Takviyeli, Naturel / PC, 20% Glass Fiber Reinforced, Natural
11	Çark / Impeller	Noril / Noryl
12	Difüzör Haznesi / Diffuser Casing	Paslanmaz Çelik (AISI 304) / Stainless Steel (AISI 304)
13	Pul / Shim	Paslanmaz Çelik (AISI 304) / Stainless Steel (AISI 304)
14	Emiş Haznesi / Suction Case	Paslanmaz Çelik (AISI 304) / Stainless Steel (AISI 304)
15	Süzgeç / Strainer	Paslanmaz Çelik (AISI 304) / Stainless Steel (AISI 304)
16	O-Ring / O-ring	Kauçuk / Rubber
17	Kaplin / Coupling	Paslanmaz Çelik (AISI 316) / Stainless Steel (AISI 316)
18	Mil / Shaft	Paslanmaz Çelik (AISI 420) / Stainless Steel (AISI 420)
19	Rondela / Washer	Paslanmaz Çelik (AISI 304) / Stainless Steel (AISI 304)
20	Pul / Shim	Paslanmaz Çelik (AISI 304) / Stainless Steel (AISI 304)
21	Kılıf Borusu / Pump Casing	Paslanmaz Çelik (AISI 304) / Stainless Steel (AISI 304)
22	Kablo Koruma / Cable Guard	Paslanmaz Çelik (AISI 304) / Stainless Steel (AISI 304)

Teknik Çizim

Technical Drawing

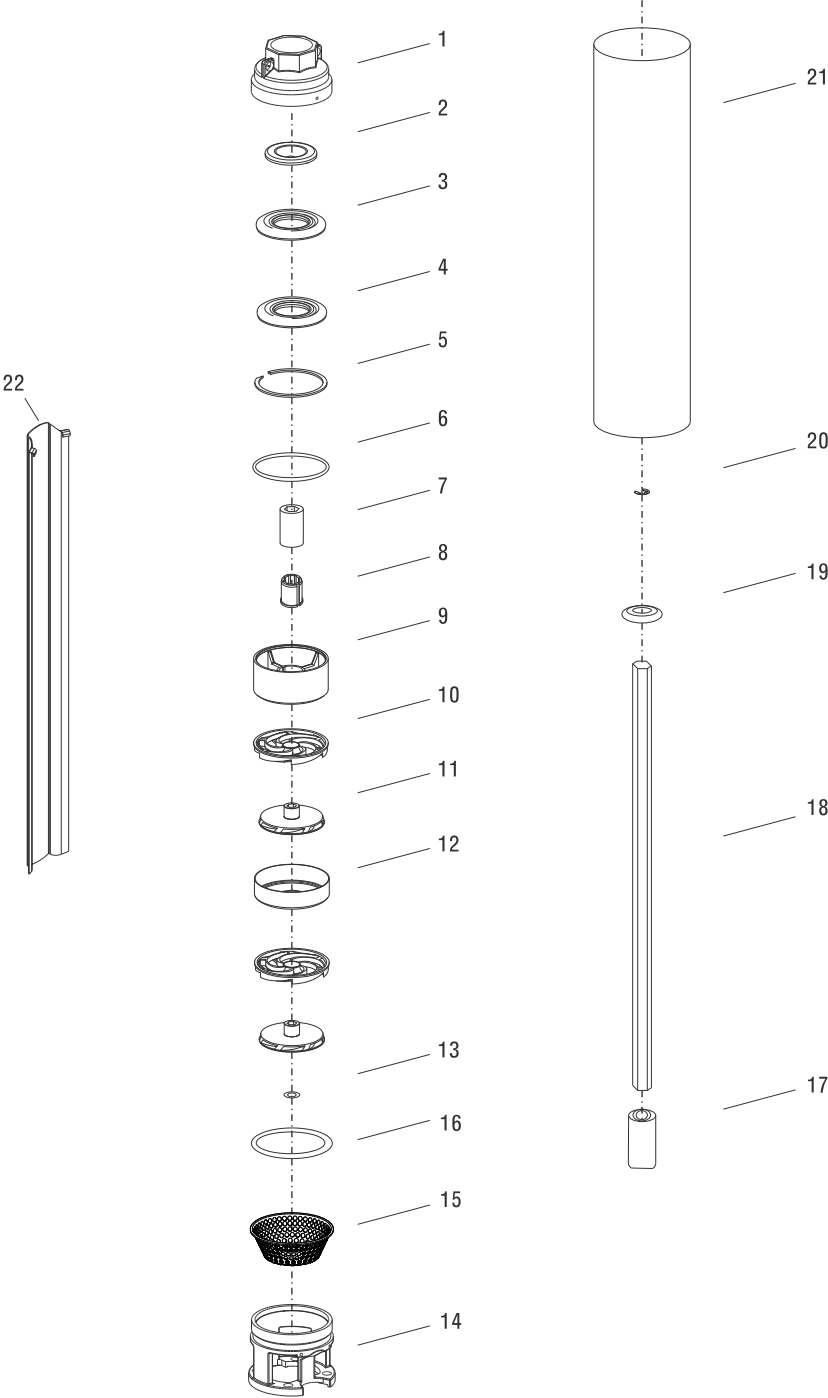

Teknik Özellikler

Technical specifications

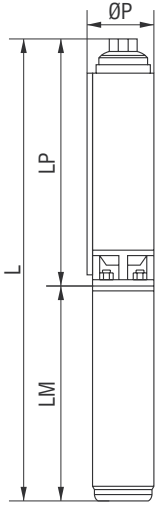

Çark : Noril
Impeller : Noryl

Difüzör : PC, %20 Cam Elyaf Takviyeli, Naturel
Diffuser : PC, 20% Glass Fiber Reinforced, Natural

Süzgeç : Paslanmaz çelik (AISI 304)
Strainer : Stainless steel (AISI 304)

Kaplin : Paslanmaz çelik (AISI 316)
Coupling : Stainless steel (AISI 316)

Klepe : Paslanmaz çelik (AISI 304)
Valve cap : Stainless steel (AISI 304)

Ara parça : Noril
Valve Housing : Noryl

Pompa mili : Paslanmaz çelik (AISI 420)
Pump shaft : Stainless steel (AISI 420)

Emiş haznesi : Paslanmaz çelik (AISI 304)
Suction case : Stainless steel (AISI 304)

Çıkış haznesi : Paslanmaz çelik (AISI 304)
Top bracket : Stainless steel (AISI 304)

Difüzör haznesi : Paslanmaz çelik (AISI 304)
Diffuser casing : Stainless steel (AISI 304)



Ölçü ve Ağırlıklar / Dimensions & Weights

Pompa Tipi Pump type	Kad. Sayısı Stages	Motor		Ölçüler / Dimensions (mm)						Ağırlık / Weight (kg)				
		kW	HP	ØP	LP	Monofaze / 1ph.		Trifaze / 3ph.		Pompa Pump	Monofaze / 1ph.		Trifaze / 3ph.	
						LM	L	LM	L		Motor	Total	Motor	Total
VSP SN 4001/10	10	0,37	0,5	98	327	361	688	346	673	3,3	8,6	11,9	7,7	11,0
VSP SN 4001/13	13	0,37	0,5	98	381	361	742	346	727	3,7	8,6	12,3	7,7	11,4
VSP SN 4001/19	19	0,55	0,75	98	486	381	867	361	847	4,7	9,3	14,0	8,5	13,2
VSP SN 4001/26	26	0,75	1	98	648	401	1.049	381	1.029	5,8	10,4	16,2	9,5	15,3
VSP SN 4001/38	38	1,1	1,5	98	911	441	1.352	401	1.312	9,2	12,2	21,4	10,4	19,6

Performans Tablosu / Performance Table

Pompa Tipi Pump type	Kad. Sayısı Stages	Motor		m ³ /h l/min	0	0,3	0,6	0,7	0,9	1,1	1,2	1,3	1,5
		kW	HP		0	5	10	12	15	18	20	22	25
VSP SN 4001/10	10	0,37	0,5	Basma Yüksekliği / Head (m)	66	60	53	50	44	37	31	25	14
VSP SN 4001/13	13	0,37	0,5		86	78	69	65	57	48	40	32	18
VSP SN 4001/19	19	0,55	0,75		126	114	101	95	84	70	59	47	26
VSP SN 4001/26	26	0,75	1		172	156	138	130	114	95	81	64	36
VSP SN 4001/38	38	1,1	1,5		251	227	202	189	167	140	118	94	52

Performans Eğrileri / Performance Curves

www.vansan.com.tr

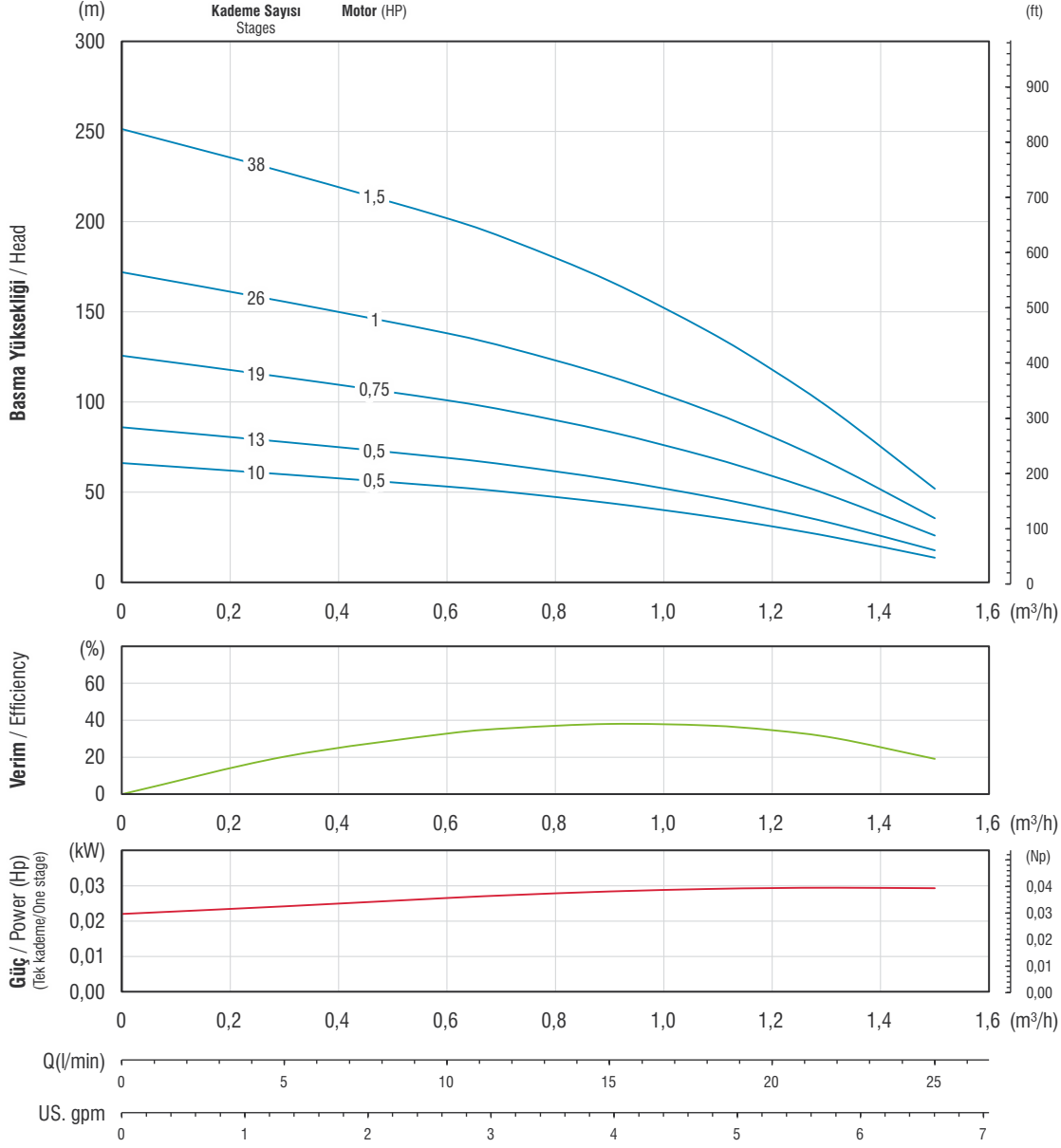

VSP SN 4001 (50Hz)

Çark kanat sayısı / No. of vanes
6

Çıkış haznesi bağlantısı / Outlet connection diameter
BSP / NPT 1¼"

Pompa dış çapı / Pump outside diameter
98 mm (kablo koruması dahil / Including cable guard)

Dönüş Yönü / Rotation
Saatın tersi yönünde / CCW

Devir / Revolution
2900 rpm

Mil çapı / Shaft diameter
11 mm



Pompa performans eğrileri 1 bar atmosfer basıncı altında 15°C sıcaklığındaki, özgül yoğunluğu 1 gr/cm³ olan su ile elde edilmiştir.
The hydraulic working characteristics have been taken with water at 15 °C, at the atmospheric pressure of 1 bar and specific gravity is 1 gr/cm³

Teknik Özellikler

Technical specifications

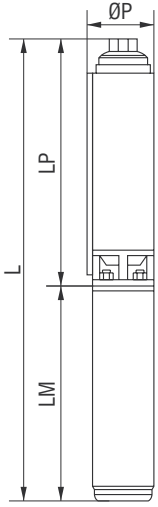

Çark : Noril
Impeller : Noryl

Difüzör : PC, %20 Cam Elyaf Takviyeli, Naturel
Diffuser : PC, 20% Glass Fiber Reinforced, Natural

Süzgeç : Paslanmaz çelik (AISI 304)
Strainer : Stainless steel (AISI 304)

Kaplin : Paslanmaz çelik (AISI 316)
Coupling : Stainless steel (AISI 316)

Klepe : Paslanmaz çelik (AISI 304)
Valve cap : Stainless steel (AISI 304)

Ara parça : Noril
Valve Housing : Noryl

Pompa mili : Paslanmaz çelik (AISI 420)
Pump shaft : Stainless steel (AISI 420)

Emiş haznesi : Paslanmaz çelik (AISI 304)
Suction case : Stainless steel (AISI 304)

Çıkış haznesi : Paslanmaz çelik (AISI 304)
Top bracket : Stainless steel (AISI 304)

Difüzör haznesi : Paslanmaz çelik (AISI 304)
Diffuser casing : Stainless steel (AISI 304)



Ölçü ve Ağırlıklar / Dimensions & Weights

Pompa Tipi Pump type	Kad. Sayısı Stages	Motor		Ölçüler / Dimensions (mm)						Ağırlık / Weight (kg)				
		kW	HP	ØP	LP	Monofaze / 1ph.		Trifaze / 3ph.		Pompa Pump	Monofaze / 1ph.		Trifaze / 3ph.	
						LM	L	LM	L		Motor	Total	Motor	Total
VSP SN 4002/05	5	0,37	0,5	98	234	361	595	346	580	2,5	8,6	11,1	7,7	10,2
VSP SN 4002/07	7	0,37	0,5	98	268	361	629	346	614	2,8	8,6	11,4	7,7	10,5
VSP SN 4002/10	10	0,55	0,75	98	321	381	702	361	682	3,3	9,3	12,6	8,5	11,8
VSP SN 4002/14	14	0,75	1	98	390	401	791	381	771	3,9	10,4	14,3	9,5	13,4
VSP SN 4002/20	20	1,1	1,5	98	494	441	935	401	895	4,9	12,2	17,1	10,4	15,3
VSP SN 4002/28	28	1,5	2	98	676	471	1.147	441	1.117	6,2	13,7	19,9	12,4	18,5
VSP SN 4002/40	40	2,2	3	98	924	561	1.485	471	1.395	9,5	18,0	27,5	13,9	23,3
VSP SN 4002/52	52	3	4	98	1.171	-	-	530	1.701	11,4	-	-	16,2	27,6

Performans Tablosu / Performance Table

Pompa Tipi Pump type	Kad. Sayısı Stages	Motor		m ³ /h l/min	0	0,6	1,2	1,8	2,1	2,4	2,7	2,82	3,0
		kW	HP		0	10	20	30	35	40	45	47	50
VSP SN 4002/05	5	0,37	0,5	Basma Yüksekliği / Head (m)	34	32	30	26	24	21	18	17	15
VSP SN 4002/07	7	0,37	0,5		48	45	42	37	33	29	25	23	20
VSP SN 4002/10	10	0,55	0,75		68	64	60	52	48	42	36	33	29
VSP SN 4002/14	14	0,75	1		95	90	83	73	67	59	50	47	41
VSP SN 4002/20	20	1,1	1,5		143	135	125	110	100	88	75	70	61
VSP SN 4002/28	28	1,5	2		190	181	167	146	133	118	101	93	82
VSP SN 4002/40	40	2,2	3		272	258	239	209	190	168	144	133	117
VSP SN 4002/52	52	3	4		353	335	310	272	247	219	187	173	152

Performans Eğrileri / Performance Curves

www.vansan.com.tr

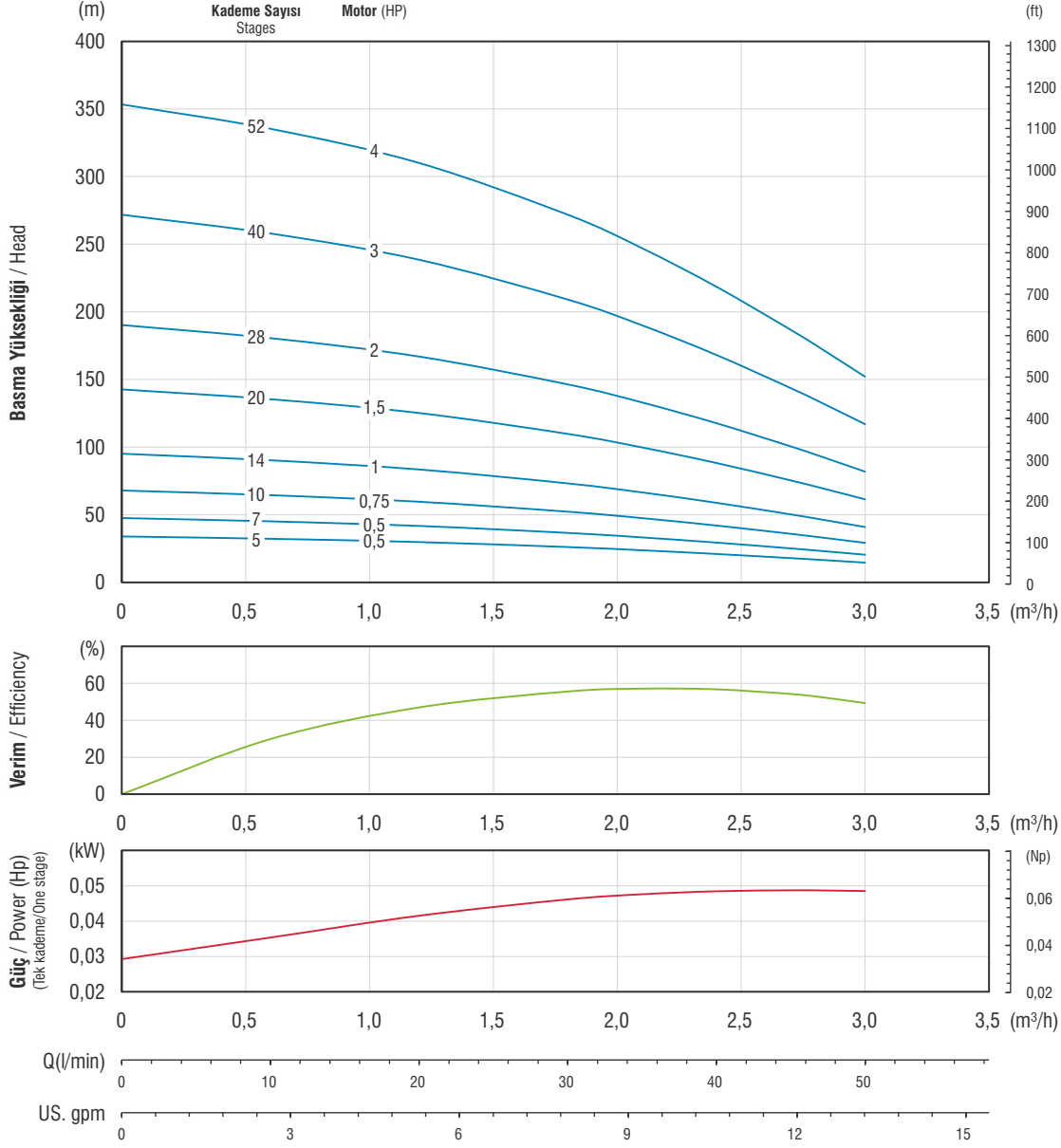

VSP SN 4002 (50Hz)

Çark kanat sayısı / No. of vanes
7

Çıkış haznesi bağlantısı / Outlet connection diameter
BSP / NPT 1¼"

Pompa dış çapı / Pump outside diameter
98 mm (kablo koruması dahil / Including cable guard)

Dönüş Yönü / Rotation
Saatin tersi yönünde / CCW

Devir / Revolution
2900 rpm

Mil çapı / Shaft diameter
11 mm



Pompa performans eğrileri 1 bar atmosfer basıncı altında 15°C sıcaklığındaki, özgül yoğunluğu 1 gr/cm³ olan su ile elde edilmiştir.
The hydraulic working characteristics have been taken with water at 15 °C, at the atmospheric pressure of 1 bar and specific gravity is 1 gr/cm³

Teknik Özellikler

Technical specifications

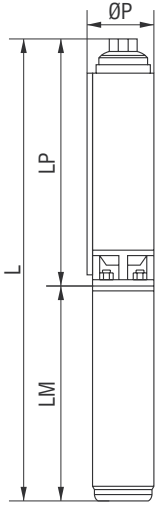

Çark : Noril
Impeller : Noryl

Difüzör : PC, %20 Cam Elyaf Takviyeli, Naturel
Diffuser : PC, 20% Glass Fiber Reinforced, Natural

Süzgeç : Paslanmaz çelik (AISI 304)
Strainer : Stainless steel (AISI 304)

Kaplin : Paslanmaz çelik (AISI 316)
Coupling : Stainless steel (AISI 316)

Klepe : Paslanmaz çelik (AISI 304)
Valve cap : Stainless steel (AISI 304)

Ara parça : Noril
Valve Housing : Noryl

Pompa mili : Paslanmaz çelik (AISI 420)
Pump shaft : Stainless steel (AISI 420)

Emiş haznesi : Paslanmaz çelik (AISI 304)
Suction case : Stainless steel (AISI 304)

Çıkış haznesi : Paslanmaz çelik (AISI 304)
Top bracket : Stainless steel (AISI 304)

Difüzör haznesi : Paslanmaz çelik (AISI 304)
Diffuser casing : Stainless steel (AISI 304)



Ölçü ve Ağırlıklar / Dimensions & Weights

Pompa Tipi Pump type	Kad. Sayısı Stages	Motor		Ölçüler / Dimensions (mm)						Ağırlık / Weight (kg)				
		kW	HP	ØP	LP	Monofaze / 1ph.		Trifaze / 3ph.		Pompa Pump	Monofaze / 1ph.		Trifaze / 3ph.	
						LM	L	LM	L		Motor	Total	Motor	Total
VSP SN 4003/05	5	0,37	0,5	98	231	361	592	346	577	2,6	8,6	11,2	7,7	10,3
VSP SN 4003/08	8	0,55	0,75	98	283	381	664	361	644	3,0	9,3	12,3	8,5	11,5
VSP SN 4003/11	11	0,75	1	98	335	401	736	381	716	3,5	10,4	13,9	9,5	13,0
VSP SN 4003/16	16	1,1	1,5	98	421	441	862	401	822	4,3	12,2	16,5	10,4	14,7
VSP SN 4003/21	21	1,5	2	98	509	471	980	441	950	5,2	13,7	18,9	12,4	17,6
VSP SN 4003/32	32	2,2	3	98	771	561	1.332	471	1.242	8,3	18,0	26,3	13,9	22,2
VSP SN 4003/42	42	3	4	98	948	-	-	530	1.478	10,3	-	-	16,2	26,5

Performans Tablosu / Performance Table

Pompa Tipi Pump type	Kad. Sayısı Stages	Motor		m ³ /h l/min	0	1,2	1,8	2,4	2,7	3,0	3,3	3,6	4,2
		kW	HP		0	20	30	40	45	50	55	60	70
VSP SN 4003/05	5	0,37	0,5	Basma Yüksekliği / Head (m)	33	32	30	27	25	23	21	18	12
VSP SN 4003/08	8	0,55	0,75		53	51	48	43	40	37	33	29	19
VSP SN 4003/11	11	0,75	1		73	70	66	60	56	51	46	40	25
VSP SN 4003/16	16	1,1	1,5		106	102	96	87	81	74	66	57	37
VSP SN 4003/21	21	1,5	2		139	134	126	114	106	97	87	75	49
VSP SN 4003/32	32	2,2	3		205	198	186	168	157	144	128	111	72
VSP SN 4003/42	42	3	4		278	268	253	228	213	195	174	151	97

Performans Eğrileri / Performance Curves

www.vansan.com.tr

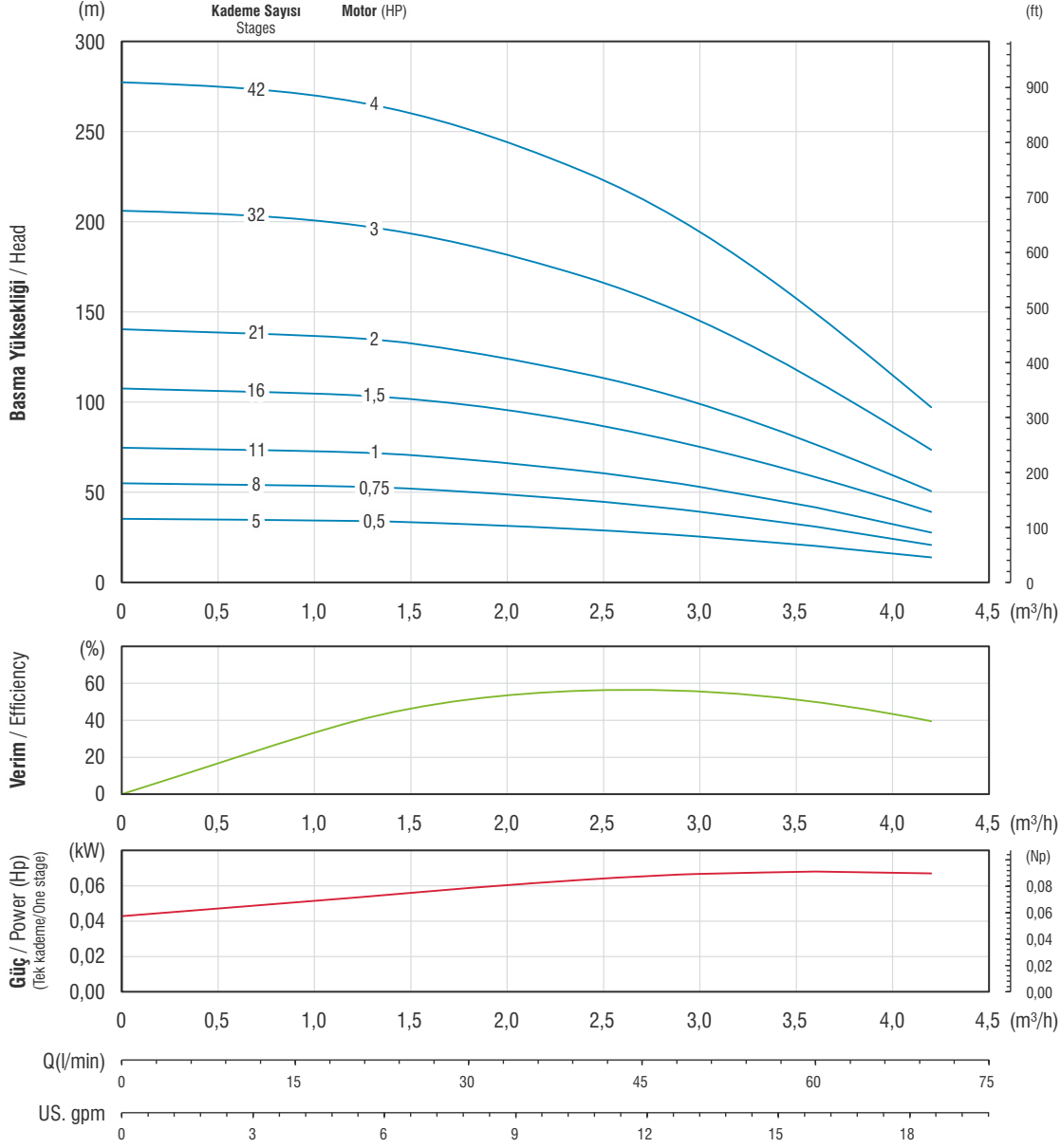

VSP SN 4003 (50Hz)

Çark kanat sayısı / No. of vanes
6

Çıkış haznesi bağlantısı / Outlet connection diameter
BSP / NPT 1¼"

Pompa dış çapı / Pump outside diameter
98 mm (kablo koruması dahil / Including cable guard)

Dönüş Yönü / Rotation
Saatin tersi yönünde / CCW

Devir / Revolution
2900 rpm

Mil çapı / Shaft diameter
11 mm

Pompa performans eğrileri 1 bar atmosfer basıncı altında 15°C sıcaklığındaki, özgül yoğunluğu 1 gr/cm³ olan su ile elde edilmiştir.
The hydraulic working characteristics have been taken with water at 15 °C, at the atmospheric pressure of 1 bar and specific gravity is 1 gr/cm³



Teknik Özellikler

Technical specifications

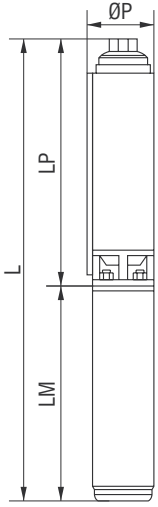

Çark : Noril
Impeller : Noryl

Difüzör : PC, %20 Cam Elyaf Takviyeli, Naturel
Diffuser : PC, 20% Glass Fiber Reinforced, Natural

Süzgeç : Paslanmaz çelik (AISI 304)
Strainer : Stainless steel (AISI 304)

Kaplin : Paslanmaz çelik (AISI 316)
Coupling : Stainless steel (AISI 316)

Klepe : Paslanmaz çelik (AISI 304)
Valve cap : Stainless steel (AISI 304)

Ara parça : Noril
Valve Housing : Noryl

Pompa mili : Paslanmaz çelik (AISI 420)
Pump shaft : Stainless steel (AISI 420)

Emiş haznesi : Paslanmaz çelik (AISI 304)
Suction case : Stainless steel (AISI 304)

Çıkış haznesi : Paslanmaz çelik (AISI 304)
Top bracket : Stainless steel (AISI 304)

Difüzör haznesi : Paslanmaz çelik (AISI 304)
Diffuser casing : Stainless steel (AISI 304)



Ölçü ve Ağırlıklar / Dimensions & Weights

Pompa Tipi Pump type	Kad. Sayısı Stages	Motor		Ölçüler / Dimensions (mm)						Ağırlık / Weight (kg)				
		kW	HP	ØP	LP	Monofaze / 1ph.		Trifaze / 3ph.		Pompa Pump	Monofaze / 1ph.		Trifaze / 3ph.	
						LM	L	LM	L		Motor	Total	Motor	Total
VSP SN 4004/5	5	0,37	0,5	98	257	361	618	346	603	2,8	8,6	11,4	7,7	10,5
VSP SN 4004/7	7	0,55	0,75	98	301	381	682	361	662	3,1	9,3	12,4	8,5	11,6
VSP SN 4004/9	9	0,75	1	98	344	401	745	381	725	3,4	10,4	13,8	9,5	12,9
VSP SN 4004/14	14	1,1	1,5	98	462	441	903	401	863	4,2	12,2	16,4	10,4	14,6
VSP SN 4004/18	18	1,5	2	98	538	471	1.009	441	979	4,8	13,7	18,5	12,4	17,2
VSP SN 4004/27	27	2,2	3	98	805	561	1.366	471	1.276	7,4	18,0	25,4	13,9	21,3
VSP SN 4004/35	35	3	4	98	972	-	-	530	1.502	9,2	-	-	16,2	25,4
VSP SN 4004/48	48	4	5,5	98	1.291	-	-	600	1.891	11,2	-	-	19,7	30,9

Performans Tablosu / Performance Table

Pompa Tipi Pump type	Kad. Sayısı Stages	Motor		m ³ /h l/min	0	1,2	1,8	2,7	3,0	3,6	4,2	4,8	5,4
		kW	HP		0	20	30	45	50	60	70	80	90
VSP SN 4004/5	5	0,37	0,5	Basma Yüksekliği / Head (m)	32	31	30	27	26	24	21	17	13
VSP SN 4004/7	7	0,55	0,75		45	43	42	38	37	33	29	24	18
VSP SN 4004/9	9	0,75	1		57	55	53	49	47	43	37	30	23
VSP SN 4004/14	14	1,1	1,5		89	86	83	76	73	66	58	47	35
VSP SN 4004/18	18	1,5	2		115	111	107	98	94	85	74	61	45
VSP SN 4004/27	27	2,2	3		172	166	160	147	141	128	111	91	68
VSP SN 4004/35	35	3	4		223	216	208	191	183	165	144	118	88
VSP SN 4004/48	48	4	5,5		306	296	285	261	251	227	197	162	120

Performans Eğrileri / Performance Curves

www.vansan.com.tr

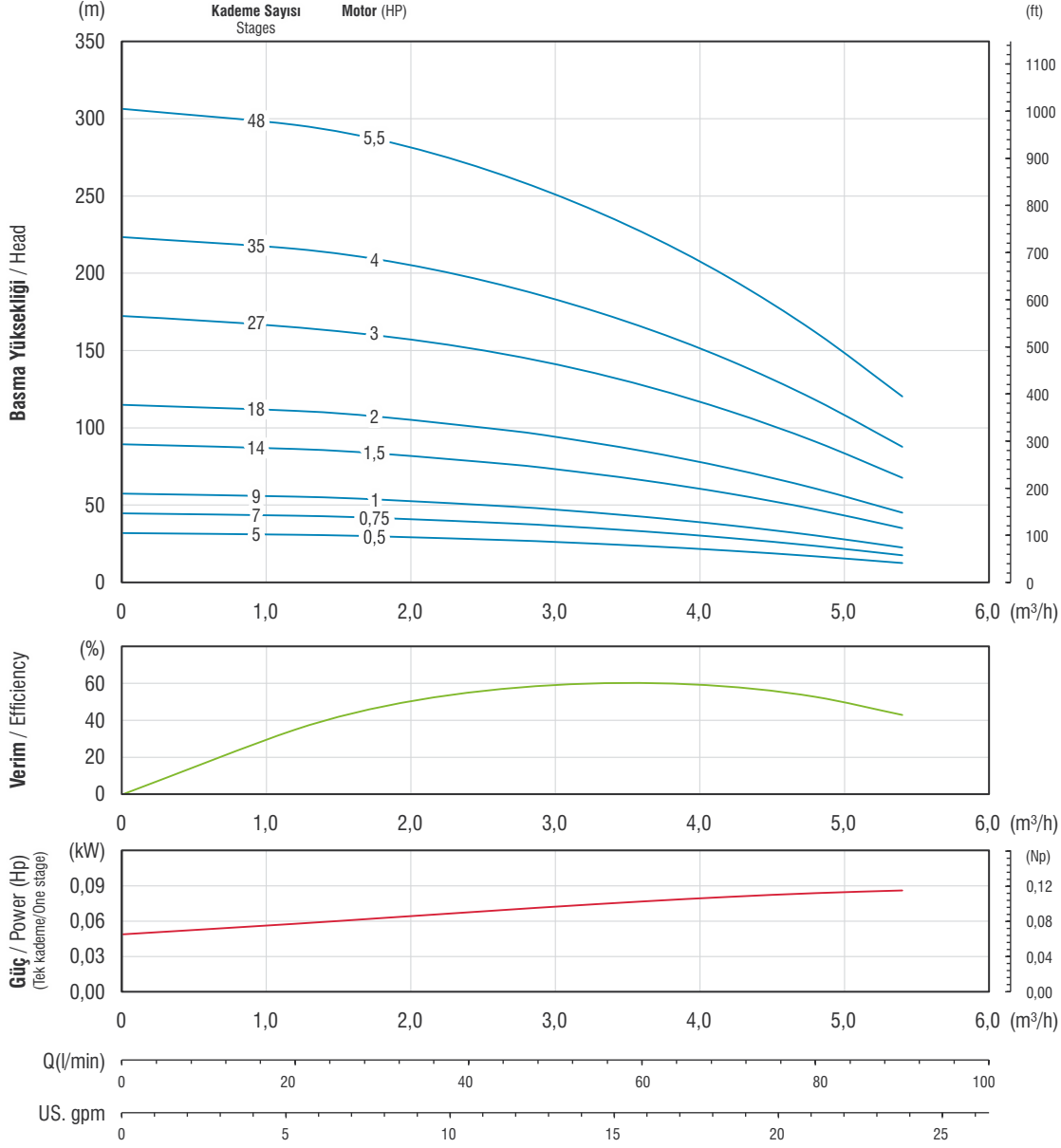

VSP SN 4004 (50Hz)

Çark kanat sayısı / No. of vanes
7

Çıkış haznesi bağlantısı / Outlet connection diameter
BSP / NPT 1¼"

Pompa dış çapı / Pump outside diameter
98 mm (kablo koruması dahil / Including cable guard)

Dönüş Yönü / Rotation
Saatin tersi yönünde / CCW

Devir / Revolution
2900 rpm

Mil çapı / Shaft diameter
11 mm



Pompa performans eğrileri 1 bar atmosfer basıncı altında 15°C sıcaklığındaki, özgül yoğunluğu 1 gr/cm³ olan su ile elde edilmiştir.
The hydraulic working characteristics have been taken with water at 15 °C, at the atmospheric pressure of 1 bar and specific gravity is 1 gr/cm³

Teknik Özellikler

Technical specifications

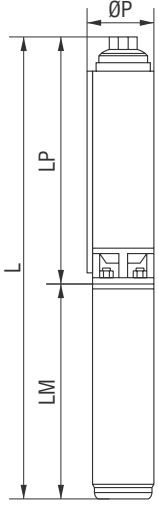

Çark : Noril
Impeller : Noryl

Difüzör : PC, %20 Cam Elyaf Takviyeli, Naturel
Diffuser : PC, 20% Glass Fiber Reinforced, Natural

Süzgeç : Paslanmaz çelik (AISI 304)
Strainer : Stainless steel (AISI 304)

Kaplin : Paslanmaz çelik (AISI 316)
Coupling : Stainless steel (AISI 316)

Klepe : Paslanmaz çelik (AISI 304)
Valve cap : Stainless steel (AISI 304)

Ara parça : Noril
Valve Housing : Noryl

Pompa mili : Paslanmaz çelik (AISI 420)
Pump shaft : Stainless steel (AISI 420)

Emiş haznesi : Paslanmaz çelik (AISI 304)
Suction case : Stainless steel (AISI 304)

Çıkış haznesi : Paslanmaz çelik (AISI 304)
Top bracket : Stainless steel (AISI 304)

Difüzör haznesi : Paslanmaz çelik (AISI 304)
Diffuser casing : Stainless steel (AISI 304)



Ölçü ve Ağırlıklar / Dimensions & Weights

Pompa Tipi Pump type	Kad. Sayısı Stages	Motor		Ölçüler / Dimensions (mm)						Ağırlık / Weight (kg)				
		kW	HP	ØP	LP	Monofaze / 1ph.		Trifaze / 3ph.		Pompa Pump	Monofaze / 1ph.		Trifaze / 3ph.	
						LM	L	LM	L		Motor	Total	Motor	Total
VSP SN 4005/4	4	0,37	0,5	98	249	361	610	346	595	2,5	8,6	11,1	7,7	10,2
VSP SN 4005/6	6	0,55	0,75	98	299	381	680	361	660	3,0	9,3	12,3	8,5	11,5
VSP SN 4005/8	8	0,75	1	98	348	401	749	381	729	3,4	10,4	13,8	9,5	12,9
VSP SN 4005/12	12	1,1	1,5	98	437	441	878	401	838	4,3	12,2	16,5	10,4	14,7
VSP SN 4005/16	16	1,5	2	98	547	471	1.018	441	988	5,2	13,7	18,9	12,4	17,6
VSP SN 4005/24	24	2,2	3	98	823	561	1.384	471	1.294	7,9	18,0	25,9	13,9	21,8
VSP SN 4005/32	32	3	4	98	1.013	-	-	530	1.543	10,1	-	-	16,2	26,3
VSP SN 4005/44	44	4	5,5	98	1.347	-	-	600	1.947	12,7	-	-	19,7	32,4

Performans Tablosu / Performance Table

Pompa Tipi Pump type	Kad. Sayısı Stages	Motor		m ³ /h l/min	0	1,8	2,7	3,0	4,2	4,8	5,1	5,4	6,0
		kW	HP		0	30	45	50	70	80	85	90	100
VSP SN 4005/4	4	0,37	0,5	Basma Yüksekliği / Head (m)	26	24	23	22	19	16	15	14	11
VSP SN 4005/6	6	0,55	0,75		38	36	34	33	28	25	23	21	16
VSP SN 4005/8	8	0,75	1		51	49	45	44	37	33	30	27	21
VSP SN 4005/12	12	1,1	1,5		77	73	68	66	56	49	45	41	32
VSP SN 4005/16	16	1,5	2		102	97	91	88	75	65	60	55	42
VSP SN 4005/24	24	2,2	3		153	146	136	133	112	98	90	82	63
VSP SN 4005/32	32	3	4		205	194	182	177	149	131	121	109	84
VSP SN 4005/44	44	4	5,5		281	267	250	243	205	180	166	150	116

Performans Eğrileri / Performance Curves

www.vansan.com.tr

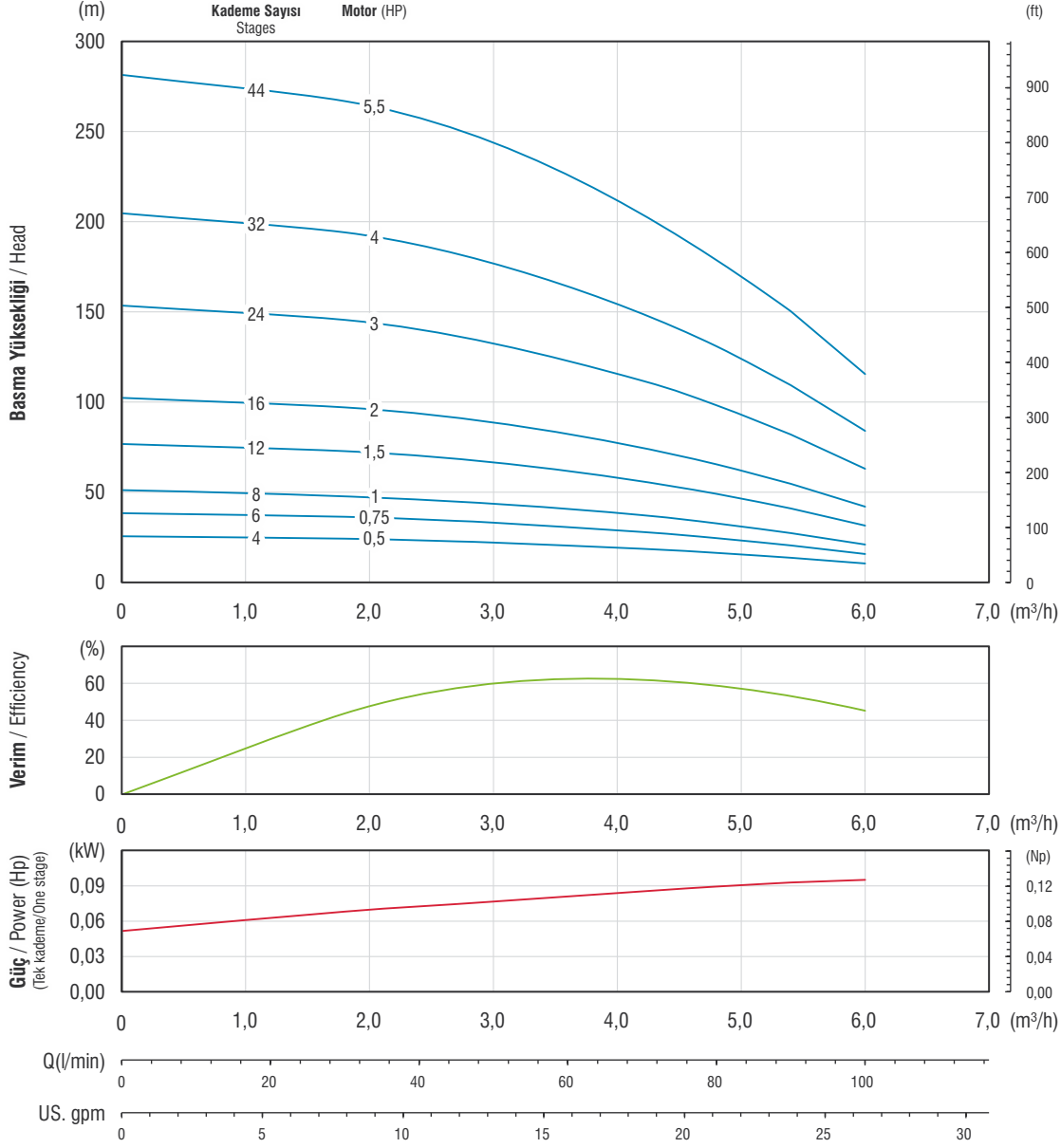

VSP SN 4005 (50Hz)

Çark kanat sayısı / No. of vanes
7

Çıkış haznesi bağlantısı / Outlet connection diameter
BSP / NPT 1¼"

Pompa dış çapı / Pump outside diameter
98 mm (kablo koruması dahil / Including cable guard)

Dönüş Yönü / Rotation
Saatın tersi yönünde / CCW

Devir / Revolution
2900 rpm

Mil çapı / Shaft diameter
11 mm



Pompa performans eğrileri 1 bar atmosfer basıncı altında 15°C sıcaklığındaki, özgül yoğunluğu 1 gr/cm³ olan su ile elde edilmiştir.
The hydraulic working characteristics have been taken with water at 15 °C, at the atmospheric pressure of 1 bar and specific gravity is 1 gr/cm³

Teknik Özellikler

Technical specifications

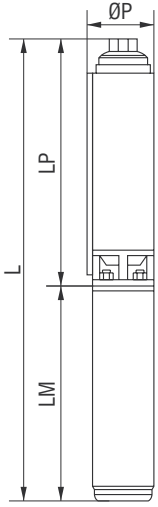

Çark : Noril
Impeller : Noryl

Difüzör : PC, %20 Cam Elyaf Takviyeli, Naturel
Diffuser : PC, 20% Glass Fiber Reinforced, Natural

Süzgeç : Paslanmaz çelik (AISI 304)
Strainer : Stainless steel (AISI 304)

Kaplin : Paslanmaz çelik (AISI 316)
Coupling : Stainless steel (AISI 316)

Klepe : Paslanmaz çelik (AISI 304)
Valve cap : Stainless steel (AISI 304)

Ara parça : Noril
Valve Housing : Noryl

Pompa mili : Paslanmaz çelik (AISI 420)
Pump shaft : Stainless steel (AISI 420)

Emiş haznesi : Paslanmaz çelik (AISI 304)
Suction case : Stainless steel (AISI 304)

Çıkış haznesi : Paslanmaz çelik (AISI 304)
Top bracket : Stainless steel (AISI 304)

Difüzör haznesi : Paslanmaz çelik (AISI 304)
Diffuser casing : Stainless steel (AISI 304)



Ölçü ve Ağırlıklar / Dimensions & Weights

Pompa Tipi Pump type	Kad. Sayısı Stages	Motor		Ölçüler / Dimensions (mm)						Ağırlık / Weight (kg)				
		kW	HP	ØP	LP	Monofaze / 1ph.		Trifaze / 3ph.		Pompa Pump	Monofaze / 1ph.		Trifaze / 3ph.	
						LM	L	LM	L		Motor	Total	Motor	Total
VSP SN 4006/7	7	0,75	1	98	394	401	795	381	775	3,9	10,4	14,3	9,5	13,4
VSP SN 4006/10	10	1,1	1,5	98	488	441	929	401	889	4,8	12,2	17,0	10,4	15,2
VSP SN 4006/14	14	1,5	2	98	613	471	1.084	441	1.054	6,0	13,7	19,7	12,4	18,4
VSP SN 4006/20	20	2,2	3	98	839	561	1.400	471	1.310	7,9	18,0	25,9	13,9	21,8
VSP SN 4006/27	27	3	4	98	1.097	-	-	530	1.627	11,1	-	-	16,2	27,3
VSP SN 4006/36	36	4	5,5	98	1.370	-	-	600	1.970	13,9	-	-	19,7	33,6
VSP SN 4006/49	49	5,5	7,5	98	1.858	-	-	655	2.513	17,7	-	-	22,5	40,2

Performans Tablosu / Performance Table

Pompa Tipi Pump type	Kad. Sayısı Stages	Motor		m ³ /h l/min	0	2,7	3,6	4,2	4,8	5,4	6,0	7,2	8,4
		kW	HP		0	45	60	70	80	90	100	120	140
VSP SN 4006/7	7	0,75	1	Basma Yüksekliği / Head (m)	42	38	36	34	33	30	28	21	14
VSP SN 4006/10	10	1,1	1,5		61	54	51	49	46	43	40	31	20
VSP SN 4006/14	14	1,5	2		85	76	72	69	65	61	55	43	28
VSP SN 4006/20	20	2,2	3		121	108	103	98	93	87	79	61	40
VSP SN 4006/27	27	3	4		164	146	139	133	125	117	107	83	53
VSP SN 4006/36	36	4	5,5		218	194	185	177	167	156	143	110	71
VSP SN 4006/49	49	5,5	7,5		297	265	252	241	228	212	194	150	97

Performans Eğrileri / Performance Curves

www.vansan.com.tr

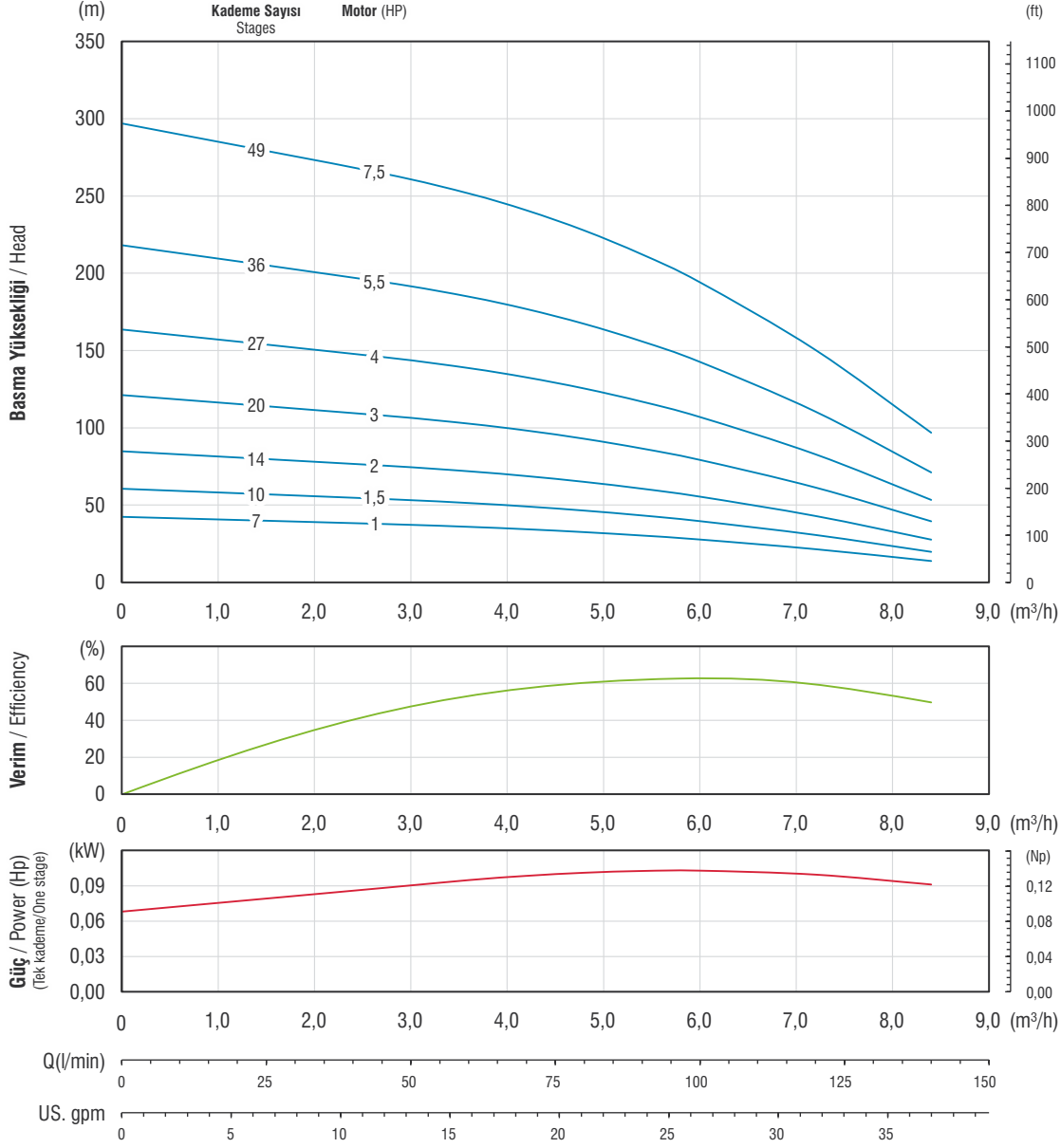

VSP SN 4006 (50Hz)

Çark kanat sayısı / No. of vanes
6

Çıkış haznesi bağlantısı / Outlet connection diameter
BSP / NPT 2"

Pompa dış çapı / Pump outside diameter
98 mm (kablo koruması dahil / Including cable guard)

Dönüş Yönü / Rotation
Saatin tersi yönünde / CCW

Devir / Revolution
2900 rpm

Mil çapı / Shaft diameter
11 mm

Pompa performans eğrileri 1 bar atmosfer basıncı altında 15°C sıcaklığındaki, özgül yoğunluğu 1 gr/cm³ olan su ile elde edilmiştir.
The hydraulic working characteristics have been taken with water at 15 °C, at the atmospheric pressure of 1 bar and specific gravity is 1 gr/cm³



Teknik Özellikler

Technical specifications

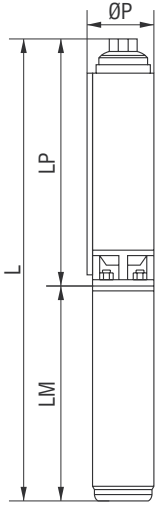

Çark : Noril
Impeller : Noryl

Difüzör : PC, %20 Cam Elyaf Takviyeli, Naturel
Diffuser : PC, 20% Glass Fiber Reinforced, Natural

Süzgeç : Paslanmaz çelik (AISI 304)
Strainer : Stainless steel (AISI 304)

Kaplin : Paslanmaz çelik (AISI 316)
Coupling : Stainless steel (AISI 316)

Klepe : Paslanmaz çelik (AISI 304)
Valve cap : Stainless steel (AISI 304)

Ara parça : Noril
Valve Housing : Noryl

Pompa mili : Paslanmaz çelik (AISI 420)
Pump shaft : Stainless steel (AISI 420)

Emiş haznesi : Paslanmaz çelik (AISI 304)
Suction case : Stainless steel (AISI 304)

Çıkış haznesi : Paslanmaz çelik (AISI 304)
Top bracket : Stainless steel (AISI 304)

Difüzör haznesi : Paslanmaz çelik (AISI 304)
Diffuser casing : Stainless steel (AISI 304)



Ölçü ve Ağırlıklar / Dimensions & Weights

Pompa Tipi Pump type	Kad. Sayısı Stages	Motor		Ölçüler / Dimensions (mm)						Ağırlık / Weight (kg)				
		kW	HP	ØP	LP	Monofaze / 1ph.		Trifaze / 3ph.		Pompa Pump	Monofaze / 1ph.		Trifaze / 3ph.	
						LM	L	LM	L		Motor	Total	Motor	Total
VSP SN 4008/4	4	0,75	1	98	297	401	698	381	678	3,0	10,4	13,4	9,5	12,5
VSP SN 4008/6	6	1,1	1,5	98	362	441	803	401	763	3,6	12,2	15,8	10,4	14,0
VSP SN 4008/8	8	1,5	2	98	422	471	893	441	863	4,3	13,7	18,0	12,4	16,7
VSP SN 4008/13	13	2,2	3	98	579	561	1.140	471	1.050	5,9	18,0	23,9	13,9	19,8
VSP SN 4008/17	17	3	4	98	704	-	-	530	1.234	7,1	-	-	16,2	23,3
VSP SN 4008/23	23	4	5,5	98	969	-	-	600	1.569	10,1	-	-	19,7	29,8
VSP SN 4008/32	32	5,5	7,5	98	1.289	-	-	655	1.944	12,8	-	-	22,5	35,3

Performans Tablosu / Performance Table

Pompa Tipi Pump type	Kad. Sayısı Stages	Motor		m ³ /h l/min	0	3,6	6,0	7,2	8,4	9,0	9,6	10,8	12,0
		kW	HP		0	60	100	120	140	150	160	180	200
VSP SN 4008/4	4	0,75	1	Basma Yüksekliği / Head (m)	26	24	22	20	19	17	16	13	10
VSP SN 4008/6	6	1,1	1,5		38	36	33	31	28	26	24	20	14
VSP SN 4008/8	8	1,5	2		51	48	44	41	37	35	32	27	19
VSP SN 4008/13	13	2,2	3		83	78	71	66	60	57	53	43	31
VSP SN 4008/17	17	3	4		108	102	93	87	79	74	69	56	41
VSP SN 4008/23	23	4	5,5		147	138	126	117	106	100	93	76	56
VSP SN 4008/32	32	5,5	7,5		204	192	175	163	148	139	129	106	77

Performans Eğrileri / Performance Curves

www.vansan.com.tr

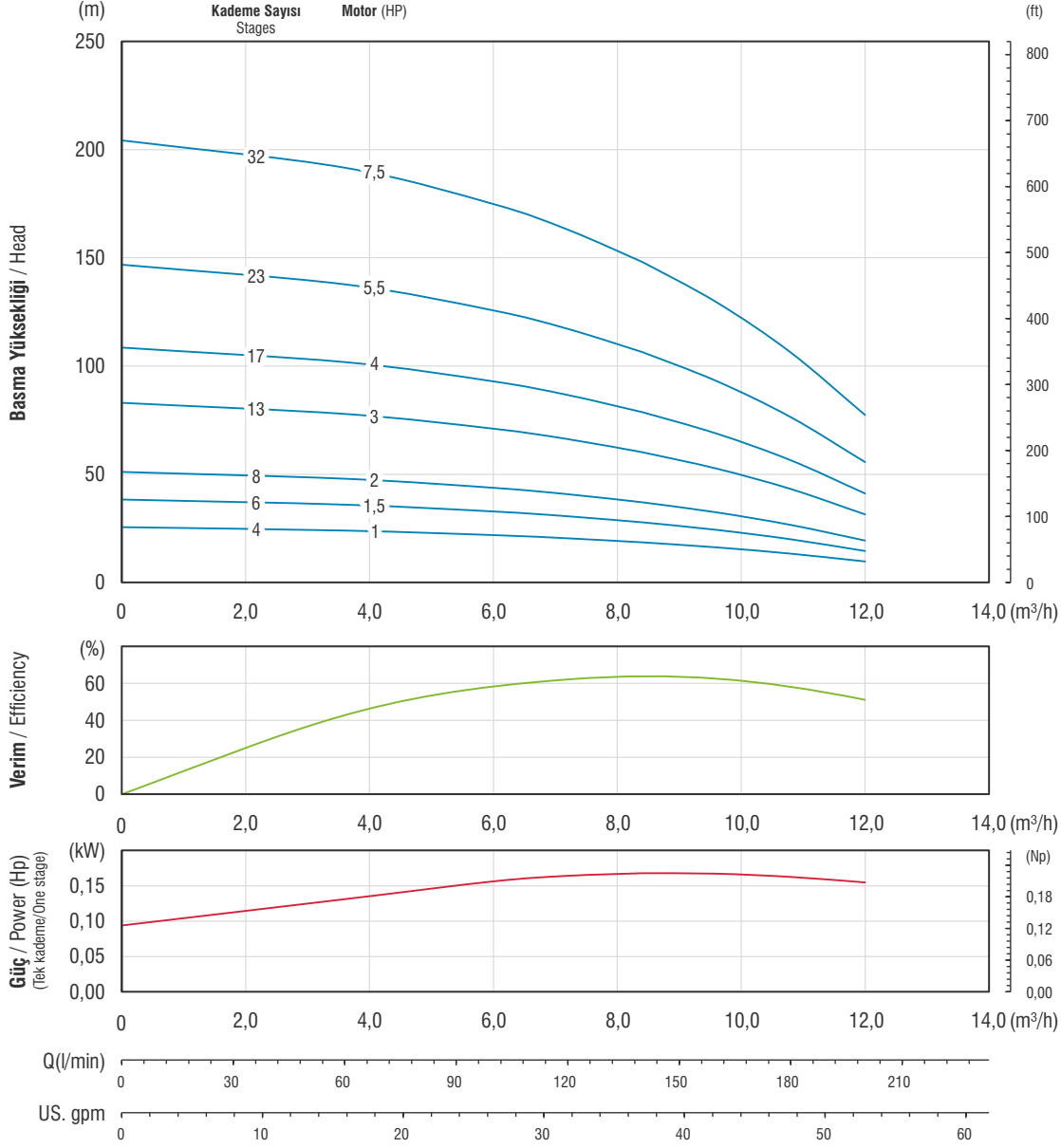

VSP SN 4008 (50Hz)

Çark kanat sayısı / No. of vanes
7

Çıkış haznesi bağlantısı / Outlet connection diameter
BSP / NPT 2"

Pompa dış çapı / Pump outside diameter
98 mm (kablo koruması dahil / Including cable guard)

Dönüş Yönü / Rotation
Saatin tersi yönünde / CCW

Devir / Revolution
2900 rpm

Mil çapı / Shaft diameter
11 mm

Pompa performans eğrileri 1 bar atmosfer basıncı altında 15°C sıcaklığındaki, özgül yoğunluğu 1 gr/cm³ olan su ile elde edilmiştir.
The hydraulic working characteristics have been taken with water at 15 °C, at the atmospheric pressure of 1 bar and specific gravity is 1 gr/cm³



Teknik Özellikler

Technical specifications

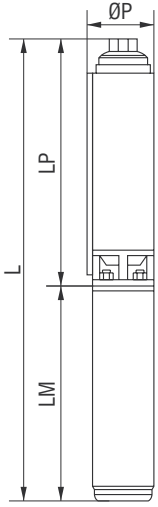

Çark : Noril
Impeller : Noryl

Difüzör : PC, %20 Cam Elyaf Takviyeli, Naturel
Diffuser : PC, 20% Glass Fiber Reinforced, Natural

Süzgeç : Paslanmaz çelik (AISI 304)
Strainer : Stainless steel (AISI 304)

Kaplin : Paslanmaz çelik (AISI 316)
Coupling : Stainless steel (AISI 316)

Klepe : Paslanmaz çelik (AISI 304)
Valve cap : Stainless steel (AISI 304)

Ara parça : Noril
Valve Housing : Noryl

Pompa mili : Paslanmaz çelik (AISI 420)
Pump shaft : Stainless steel (AISI 420)

Emiş haznesi : Paslanmaz çelik (AISI 304)
Suction case : Stainless steel (AISI 304)

Çıkış haznesi : Paslanmaz çelik (AISI 304)
Top bracket : Stainless steel (AISI 304)

Difüzör haznesi : Paslanmaz çelik (AISI 304)
Diffuser casing : Stainless steel (AISI 304)



Ölçü ve Ağırlıklar / Dimensions & Weights

Pompa Tipi Pump type	Kad. Sayısı Stages	Motor		Ölçüler / Dimensions (mm)						Ağırlık / Weight (kg)				
		kW	HP	ØP	LP	Monofaze / 1ph.		Trifaze / 3ph.		Pompa Pump	Monofaze / 1ph.		Trifaze / 3ph.	
						LM	L	LM	L		Motor	Total	Motor	Total
VSP SN 4012/7	7	1,5	2	98	550	471	1.021	441	991	5,7	13,7	19,4	12,4	18,1
VSP SN 4012/10	10	2,2	3	98	711	561	1.272	471	1.182	7,2	18,0	25,2	13,9	21,1
VSP SN 4012/14	14	3	4	98	1.019	-	-	530	1.549	9,3	-	-	16,2	25,5
VSP SN 4012/19	19	4	5,5	98	1.270	-	-	600	1.870	13,0	-	-	19,7	32,7
VSP SN 4012/26	26	5,5	7,5	98	1.645	-	-	655	2.300	16,5	-	-	22,5	39,0
VSP SN 4012/34	34	7,5	10	98	2.070	-	-	795	2.865	20,5	-	-	28,8	49,3

Performans Tablosu / Performance Table

Pompa Tipi Pump type	Kad. Sayısı Stages	Motor		m ³ /h l/min	0	6,0	7,2	8,4	9,6	10,8	12,0	13,2	14,4
		kW	HP		0	100	120	140	160	180	200	220	240
VSP SN 4012/7	7	1,5	2	Basma Yüksekliği / Head (m)	44	38	36	34	31	28	25	21	17
VSP SN 4012/10	10	2,2	3		63	54	51	48	44	40	36	30	24
VSP SN 4012/14	14	3	4		88	76	72	67	62	56	50	42	34
VSP SN 4012/19	19	4	5,5		120	103	98	91	84	77	68	58	46
VSP SN 4012/26	26	5,5	7,5		164	141	134	125	116	105	93	79	63
VSP SN 4012/34	34	7,5	10		214	184	175	164	151	137	121	103	83

Performans Eğrileri / Performance Curves

www.vansan.com.tr

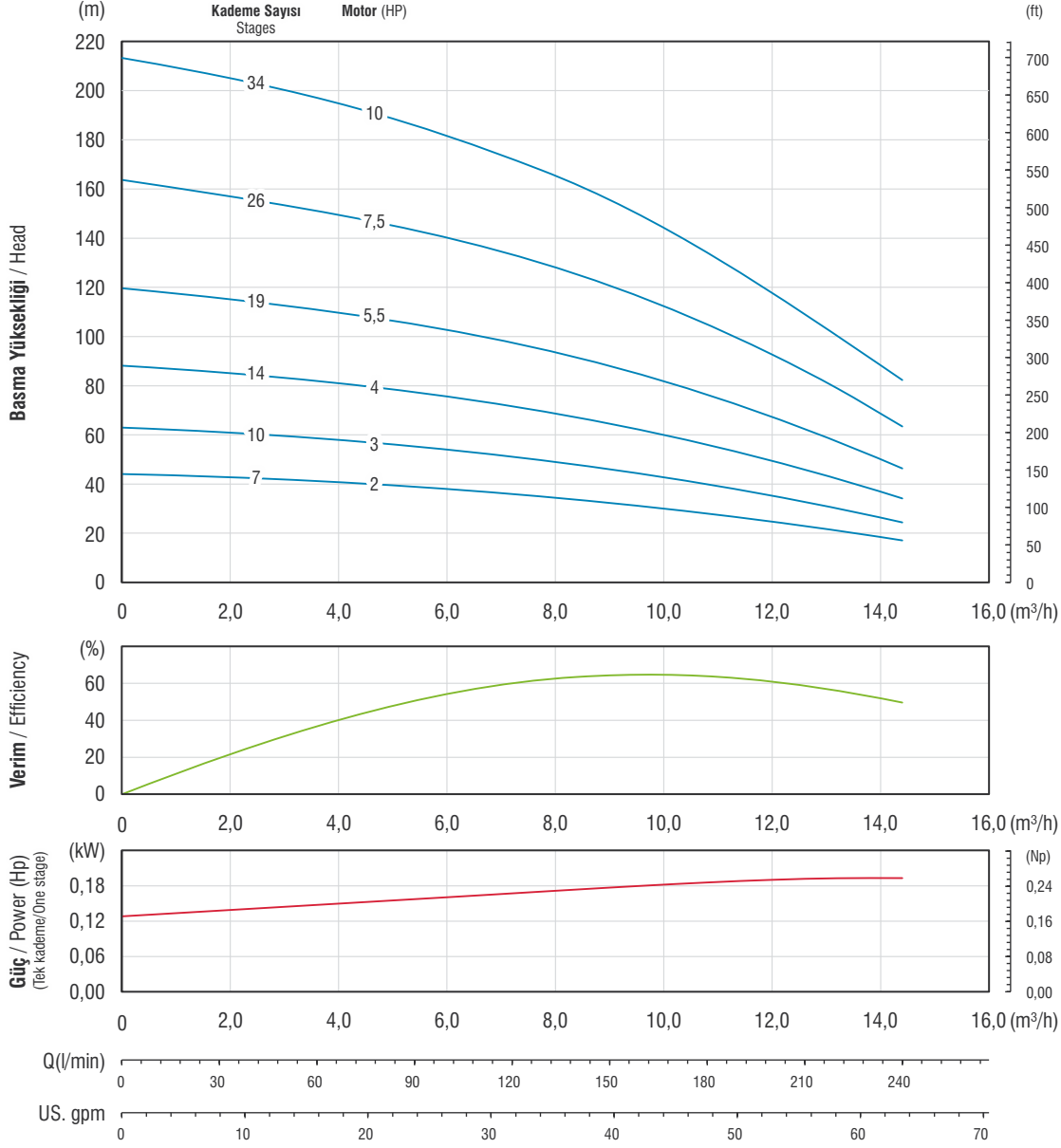

VSP SN 4012 (50Hz)

Çark kanat sayısı / No. of vanes
6

Çıkış haznesi bağlantısı / Outlet connection diameter
BSP / NPT 2"

Pompa dış çapı / Pump outside diameter
98 mm (kablo koruması dahil / Including cable guard)

Dönüş Yönü / Rotation
Saatin tersi yönünde / CCW

Devir / Revolution
2900 rpm

Mil çapı / Shaft diameter
11 mm



Pompa performans eğrileri 1 bar atmosfer basıncı altında 15°C sıcaklığındaki, özgül yoğunluğu 1 gr/cm³ olan su ile elde edilmiştir.
The hydraulic working characteristics have been taken with water at 15 °C, at the atmospheric pressure of 1 bar and specific gravity is 1 gr/cm³

Teknik Özellikler

Technical specifications

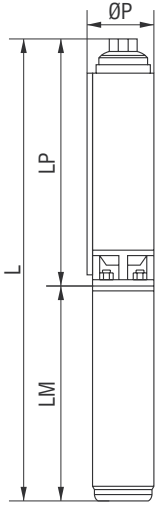

Çark : Noril
Impeller : Noryl

Difüzör : PC, %20 Cam Elyaf Takviyeli, Naturel
Diffuser : PC, 20% Glass Fiber Reinforced, Natural

Süzgeç : Paslanmaz çelik (AISI 304)
Strainer : Stainless steel (AISI 304)

Kaplin : Paslanmaz çelik (AISI 316)
Coupling : Stainless steel (AISI 316)

Klepe : Paslanmaz çelik (AISI 304)
Valve cap : Stainless steel (AISI 304)

Ara parça : Noril
Valve Housing : Noryl

Pompa mili : Paslanmaz çelik (AISI 420)
Pump shaft : Stainless steel (AISI 420)

Emiş haznesi : Paslanmaz çelik (AISI 304)
Suction case : Stainless steel (AISI 304)

Çıkış haznesi : Paslanmaz çelik (AISI 304)
Top bracket : Stainless steel (AISI 304)

Difüzör haznesi : Paslanmaz çelik (AISI 304)
Diffuser casing : Stainless steel (AISI 304)



Ölçü ve Ağırlıklar / Dimensions & Weights

Pompa Tipi Pump type	Kad. Sayısı Stages	Motor		Ölçüler / Dimensions (mm)						Ağırlık / Weight (kg)				
		kW	HP	ØP	LP	Monofaze / 1ph.		Trifaze / 3ph.		Pompa Pump	Monofaze / 1ph.		Trifaze / 3ph.	
						LM	L	LM	L		Motor	Total	Motor	Total
VSP SN 4016/7	7	2,2	3	98	614	561	1.175	471	1.085	5,8	18,0	23,8	13,9	19,7
VSP SN 4016/10	10	3	4	98	822	-	-	530	1.352	7,7	-	-	16,2	23,9
VSP SN 4016/14	14	4	5,5	98	1.092	-	-	600	1.692	10,2	-	-	19,7	29,9
VSP SN 4016/19	19	5,5	7,5	98	1.435	-	-	655	2.090	13,3	-	-	22,5	35,8
VSP SN 4016/27	27	7,5	10	98	1.975	-	-	795	2.770	18,2	-	-	28,8	47,0

Performans Tablosu / Performance Table

Pompa Tipi Pump type	Kad. Sayısı Stages	Motor		m ³ /h l/min	0	7,2	9,6	12,0	14,4	16,8	19,2	22,8	24,0
		kW	HP		0	120	160	200	240	280	320	380	400
VSP SN 4016/7	7	2,2	3	Basma Yüksekliği / Head (m)	42	38	35	32	28	25	21	14	12
VSP SN 4016/10	10	3	4		60	54	50	46	41	35	30	21	17
VSP SN 4016/14	14	4	5,5		85	76	70	64	57	50	42	29	24
VSP SN 4016/19	19	5,5	7,5		115	103	95	87	77	67	57	39	32
VSP SN 4016/27	27	7,5	10		163	146	136	123	110	96	80	55	46

Performans Eğrileri / Performance Curves

www.vansan.com.tr

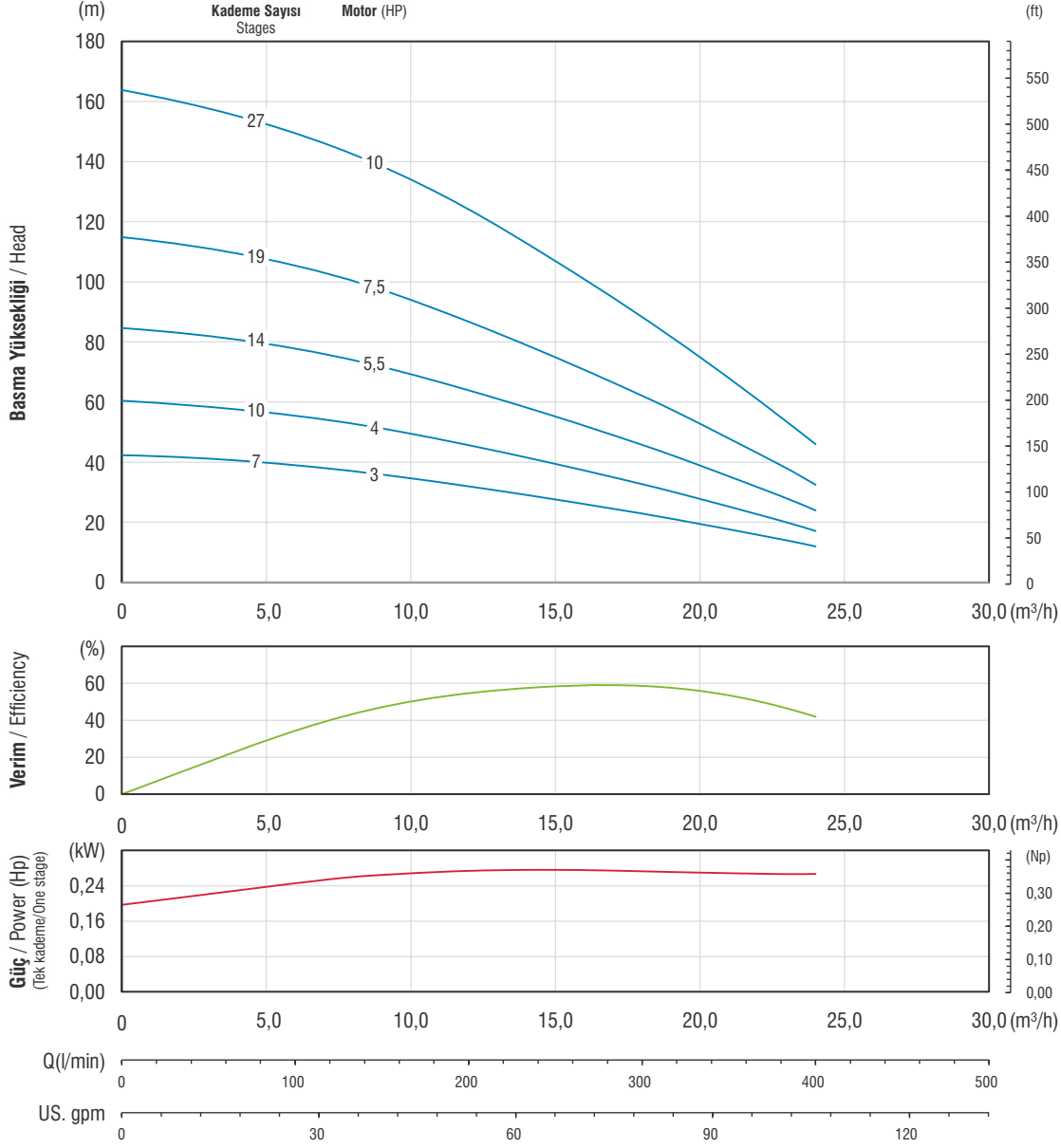

VSP SN 4016 (50Hz)

Çark kanat sayısı / No. of vanes
6

Çıkış haznesi bağlantısı / Outlet connection diameter
BSP / NPT 2"

Pompa dış çapı / Pump outside diameter
98 mm (kablo koruması dahil / Including cable guard)

Dönüş Yönü / Rotation
Saatın tersi yönünde / CCW

Devir / Revolution
2900 rpm

Mil çapı / Shaft diameter
11 mm



Pompa performans eğrileri 1 bar atmosfer basıncı altında 15°C sıcaklığındaki, özgül yoğunluğu 1 gr/cm³ olan su ile elde edilmiştir.
The hydraulic working characteristics have been taken with water at 15 °C, at the atmospheric pressure of 1 bar and specific gravity is 1 gr/cm³

Notlar:

A series of horizontal dotted lines for writing notes.



10035 Sk. No:10 A.O.S.B. 35620 - Cigli, Izmir / TURKEY
T: +90 (232) 376 76 50 • F: +90 (232) 328 01 68
www.vansan.com.tr • vansan@vansan.com.tr

